



ALUMINUM SIDING INSTALLATION GUIDE



GENTEK[®]

GENTEK BUILDING PRODUCTS

ALUMINUM SIDING INSTALLATION

General Information

Gentek vinyl products, horizontal and vertical siding and soffit, Gentek aluminum siding is an attractive pre-finished cladding system which includes a full range of correctly fitting accessories. During installation, handle siding panels and other components with care to avoid dents, scratches, etc. which would affect the appearance of the completed job.

Hands and tools should be clean, and cutting benches and other work surfaces free from debris.

This manual describes the basic steps for installing siding on a simple home.

Problems will arise that are not covered. Do the simplest parts of the job to gain experience before tackling the more complicated areas.

All measurements are written in the SI metric system. Nominal imperial equivalents are provided in brackets.

Before starting the job read this manual.

Have the following tools on hand:

- Measuring tape- 30 m (100 ft)
- Level- 610 mm (24 in.)
- Chalk line & plumb line
- Crosscut wood saw
- Roofer's knife or equivalent
- Portable brake (min. 10 ft)
- Aviation snips
- Metal file
- Crimping tool
- Set Robertson screw drivers
- Extension ladder
- Extension cord- 30m (100 ft)
- Circular saw with cutting blade for aluminum, e.g. 2 mm (1/16 in.) thick and ten or more teeth per inch
- Carpenters rule
- Tin snips
- Cutting bench
- Hacksaw
- Electric drill
- Corner tool
- Claw hammer
- Nailset
- Slotted screw driver
- Caulking gun
- Adjustable scaffold
- Scrap container

Important

Use only siding of the same paint batch number for the entire installation or any one wall of the installation.

Then Proceed in the following order

Note: If necessary, you can adapt the established procedure according to particular conditions.

Prepare the building
Caulk

For horizontal siding:

- Apply all trims including corner posts
- Apply siding panels
- Apply corner caps

For vertical siding:

- Be familiar with the principles given for horizontal siding
- Apply all trims
- Apply siding panels

Wash the panels and touch up any scratches
Re-install any fixtures and clean up site

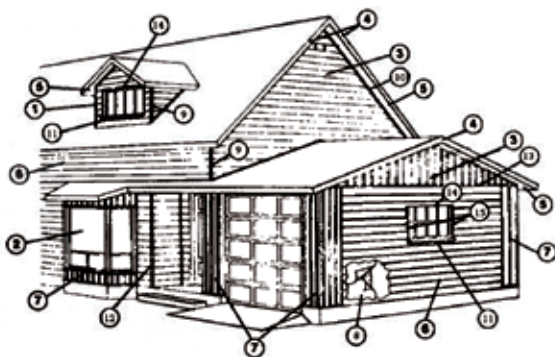

- | | |
|---------------------------|-------------------------------------|
| 1 Dormer | 9 Corner caps |
| 2 Bay Window | 10 "J" trim |
| 3 Gable End | 11 Undersill (General purpose) trim |
| 4 Fascia | 12 Outside Corner Post |
| 5 Soffit | 13 Vertical Base (Belt Line) trim |
| 6 Horizontal siding panel | 14 Drip Cap |
| 7 Vertical siding panel | 15 "L" trim or "J" trim |
| 8 Sheathing paper | |

Gentek Building Products Installation Guides are for information only. If you are unsure of any procedure, consult Gentek Building Products or a qualified tradesman for advice. They can provide the information you need- and save you time and trouble.

Preparation

Renovation

Remove all fixtures which would otherwise interfere with the installation, such as, downspouts, electrical service fittings, letter boxes, shutters, etc.

Tie back shrubbery and trees.

Cut the ends of each window sill flush with window casing (with the owner's permission).

Where required to ensure straight, tight fit of siding and accessories over old construction, remove existing caulking around openings.

Wooden Exterior Walls - Check for evidence of dry rot or moisture, then remove and replace all rotted wood and nail all loose boards securely in place.

Furr out irregularities to provide an even surface.

Asbestos Shingle, Asphalt or Stucco Exterior Walls – If the wall is sound, apply wood strapping on 400 mm (16 inch) centres.

New Construction

Apply asphalt impregnated breather type sheathing paper conforming with the requirements of CAN 2-51. 32-M "Sheathing Membrane – Breather Type".

Apply the paper with either galvanized staples or aluminum nails. As required by the National Building Code and the C.C.M.C. Residential Standards Canada, Current Editions allow at least a 100 mm (4") overlap of the top course over a bottom course; overlap ends a minimum of 100 mm (4"); and wrap the paper around corners at least 100 mm (4"). Apply as closely as possible around openings such as doors and windows. As required by C.C.M.C. to prevent water entry above openings and at foundation walls, apply sheathing paper so that it covers drip caps (window head flashings) and belt line trims (base flashings).

Renovation and New Construction

To improve sealing, apply bead of caulking meeting CGSB specification 19-GP-14M under all trims around window and door openings.

No caulking is required under eaves.

DO NOT USE OIL-BASED CAULKING.

Cutting

Renovation or New Construction)

Crosscuts – Cut siding using a power saw or tin snips. If a power saw is used, it should be equipped with a cutting blade for aluminum 2mm (1/16") thick and 10 or more teeth per 25mm (1").

To avoid marring paint make saw cuts so that the saw burr is toward the back of the siding.

ALL SAW BURRS MUST BE REMOVED.

Cut the siding slowly and carefully because the metal has a tendency to chatter against the saw blade. Draw saw toward locking edge. (See fig. 1).

Nesting and cutting a number of pieces at one time is not recommended as this may scratch the paint.

Leave sufficient clearance when butting a panel end against a trim, to allow for movement of the aluminum because of changes in temperature.

End notches can be cut with tin snips to look the same as factory-notched end.

Lengthwise Cuts – Score a line using a straight edge and utility knife. Bend the piece back and forth until it breaks free.

Removing a Section – Cut two slots in the panel with saw or snips. Score the panel between these two cuts and break the section out. (See Fig. 2).

Accessories- Cut with a power saw or hacksaw. It may be necessary to use tin snips or aviation snips due to the complexity of some shapes. It is often necessary to pry open the bead of an accessory after cutting since snips tend to pinch the bead where the cut is made.

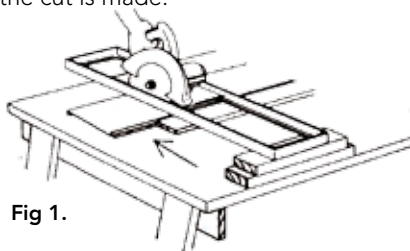

Fig 1.

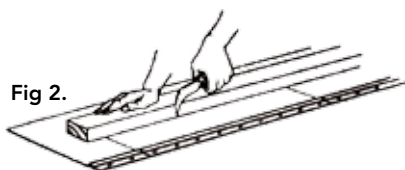

Fig 2.

Nailing

Use only aluminum nails when nailing siding or aluminum accessories, to avoid rust streaks on the siding.

TO AVOID DISTORTION, DO NOT DRIVE NAILS TIGHT IN EITHER SIDING OR INDIVIDUAL CORNER CAPS.

In siding, drive nails in centre of slotted nail holes to allow for expansion and contraction. (See Figs. 3 & 4).

Siding

Use 50 mm (2") nails with backed siding so that they will be long enough to go through the siding, backer and into the existing wall. With unbacked siding, 38 mm (1 ½") nails are sufficient. At an overlap, the nails in the bottom panel should not be driven closer than 150 mm (6") from the end of the panel. Nail the overlapping panel in the end hole to give a snug, not tight, lap. (See Fig. 5). Nail on a maximum of 800 mm (32") centres, into studs, or strapping, wherever possible.

Accessories

For all trims use 38 mm (1 ½") nails. For individual corner caps – with unbacked siding use 2 – 50 mm (2") nails per cap, with backed siding use 2 – 63 mm (2 ½") nails per cap. (For nailing details see Fig. 13).

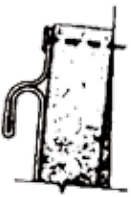

Fig 3.

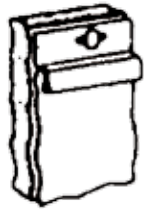

Fig 4.

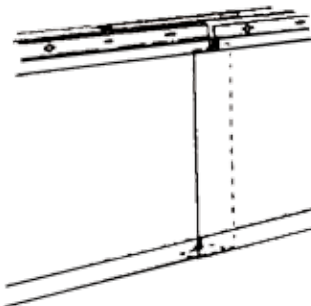

Fig 5.

Starter Strip – Aluminum

(Renovation or New Construction)

Note: Where corner posts are being used they must be installed before starter strip is applied.

The starter strip must be straight, level and line up at all corners since it will determine the line of all the siding panels. Determine the lowest point from which siding is to be applied. Measure the width of the starter strip from this point and stretch a chalk line to a corner, using a level and sighting along the line to make sure that it is level and straight.

Snap the line to provide a reference mark for the starter strip. Repeat on the remaining sides of the house making sure that the line meets on all corners.

Nail the top of the starter strip along this line furring approximately 10 mm (3/8") so that the first panel will have the same pitch as all the succeeding panels. Furring is not required when backer board is not being used. If the lowest panel is above eye level, the furring strip will be visible. To prevent this, the following procedure is recommended:

Form the special trim shown in Fig. 6 from coil stock or a piece of panel (each panel will make two lengths of trim). Nail this trim underneath the starter strip to cover the furring strip. This added effort greatly improves the appearance of the finished job.

Porches, Entrances, or Other Variations – Adjust the position of the starter strip at the base so that the course of the siding will run evenly around the house.

Masonry or Other Veneer Facing – Where these exist flush or set back from the side of the house, establish the line for the starter strip from the low point of masonry. Install star strip so that its bottom edge is 12 mm (1/2") below the line.

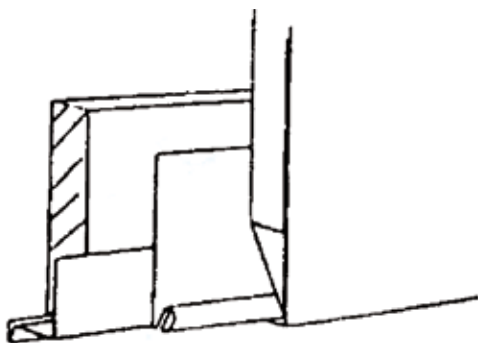
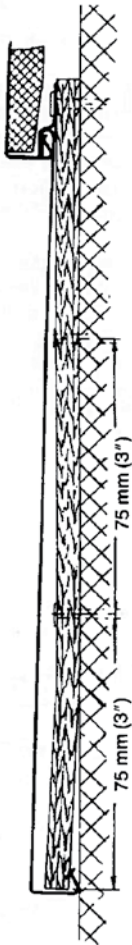

Fig 6.

Starter Strip – Plywood

(New Construction)

Shrinkage of unseasoned framing lumber can cause siding panels to disengage from standard aluminum starter strip. This problem can be avoided through the use of plywood starter strip. Use only exterior grade plywood, 275 mm (11") wide for Double 4 siding. Install plywood with 50 mm (2") aluminum siding nails on 300 mm (12") maximum centres using two horizontal rows of nails for 225 mm (9") plywood and three rows for 275 mm (11") wide plywood. The first row should be approximately 75 mm (3"), the second row approximately 150 mm (6") and the third row approximately 225 mm (9") above the bottom edge of the plywood. Where possible, stagger nail locations in adjacent rows.



Corner Posts – Outside

Install all corner posts before applying any siding. When installing on 2nd storey level, allow the post to extend approximately 38 mm (1 ½") below the bottom of the first course of siding to provide for closing off or "capping" the bottom of the post. Apply furring at low spots.

Nail the post through the nailing flange on about 300 mm (12") centres making sure that the posts are plumb and square with the house. Cut the siding panels square and butt to the corner post. If using individual corner caps, install as detailed on page 12.

How to make an inside corner piece of desired length

Use a piece of painted aluminum sheet, 150 mm (6") wide and adjusted to proper length. If you use a portable folding brake, insert a strip of aluminum sheet (painted side down) and fold along centre at a 90° angle. On each side of the corner now shaped, measure a distance equal to the width of the mouldings used and make a light marking on the side of the corner (painted side up) up to the mark, and fold side at a 90° angle. Repeat with other side, to obtain an inside corner piece of desired length. To install, follow the same procedure used for outside corner pieces.

If you do not have a folding brake, use two standard J (3/4") trims, place the trims back to back to form a 90 degree inside corner.

Window and Door Trim

Apply trim around door and window frames before installing siding panels.

Measure overall height and width of each door or window frame. Under the window frame, use undersill (general purpose) trim cut to extend 25 mm (1") beyond the width of the window at either side. Furr out undersill trim to maintain the proper pitch of the panel. On the sides of the frame, use large "J" trim with backed siding or medium "J" trim with unbacked siding.

Cut the "J" trim to extend 25 mm (1") above the height of the frame. On top of the frame, use "Drip Cap" cut to extend 25 mm (1") beyond the width of the frame at either side. Bend base of drip cap down over the "J" trim. (See Fig. 7).

Nail all trims in place on 300 mm (12") centres using 38 mm (1 ½") nails.

Note: To improve sealing, it is recommended that a bead of caulking be applied under all trims.

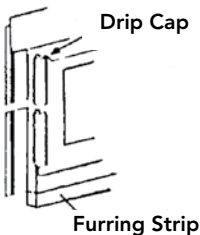

Fig 7.

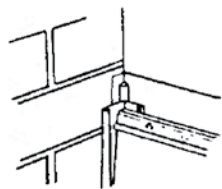

Fig 8.

Siding Panels – Horizontal

Laps

On the front and back, overlap ends away from entrances so laps will be less noticeable when entering the house. On the sides of the house, start at the rear and work toward the front, to have overlapping ends facing the rear.

Lap field cut ends under factory ends whenever possible, so that laps will be less noticeable.

Make as few laps as possible on the front of the house.

Use random panel lengths so that the laps are not conspicuously lined up one above the other. Panels cut at the end of a course may be used to start the next course.

Application

Start the first course by engaging the bottom edge of the panel into the starter strip and pulling up firmly until it locks into place. Do not distort the shadow line by pulling the panel too hard.

Nail on maximum 800 mm (32") centres, into studs or strapping wherever possible.

Install furring as the job proceeds, using furring strips under windows, in low spots, and wherever else it may be necessary to maintain the line and pitch of the panels.

Make sure that panels on both sides of the corner meet at the same level.

Depending on how much furring is used, keep backed siding between 6 mm (1/4") and 12 mm (1/2") away from the corner, and unbacked siding between 12 mm (1/2") and 19 mm (3/4") away.

Check the alignment of the panels, either by placing two small pieces of wood under the ends of the panels so that they meet at the corner, or by applying corner caps after each course so that adjustments can be made as work proceeds. (See Fig. 9). Apply succeeding courses in the same manner, holding the panel at the bottom and slipping it into the top interlock of the panel beneath.

Note: Except where lack of space between openings make it impossible to install a longer panel, do not install a horizontal siding panel less than 600 mm (24") in length.

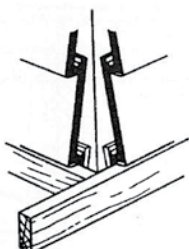

Fig 9.

Backer Board

In renovation and new construction, backer board is recommended with all 200 mm (8") horizontal siding. Backer board is not necessary behind vertical or Double 4" siding.

Backer board may be polystyrene or asphalt-impregnated fiber. To install the backer board, proceed as follows:

Lock the first siding panel into the starter strip pulling up firmly. Put the top of the panel slightly towards you. Slip the piece of backer board down behind the panel with the beveled edge of the bottom facing the wall. (See Fig. 10).

Push the board firmly down into the channel of the siding. Nail the siding as explained previously.

Stagger each length of board with respect to the siding panels to prevent the ends of both backer board and siding panel from falling in line.

Under eaves and openings, it may be easier to nail the backer board temporarily to the house before applying the siding panel. Use only one or two nails through the top of the board to leave the bottom free to fit into the siding panel.

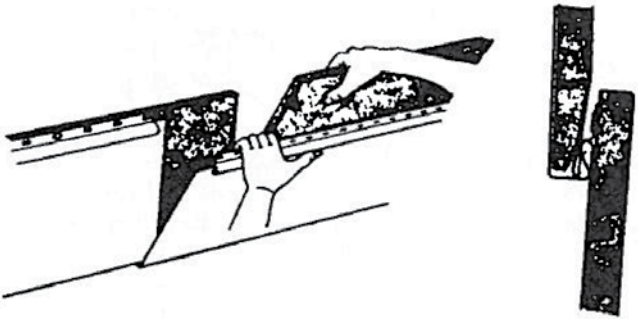

| Fig 10.

Corner Caps

Start applying the individual corner caps after installing several rows of siding and keep applying caps as work progresses. (See Fig. 11).

Be sure the bottom lock of each corner cap is pressed into the groove between the panels and is securely locked to eliminate any open areas between panel and corner surfaces.

It may be necessary to pry the end of the groove open slightly with a screwdriver to make the cap fit properly. (See Fig. 12).

Squeeze the sides of the cap slightly before applying to ensure a snug fit with the panel.

Use a corner tool to press the cap into place.

DO NOT USE A HAMMER.

Nail through the outer two of the three nail holes provided in the cap, using 50 mm (2") nails for unbacked siding, 63 mm (2 1/2") nails for backed siding. (See Fig. 13).

DO NOT DRIVE NAILS TIGHT.

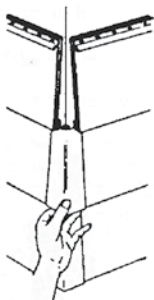

Fig 11.

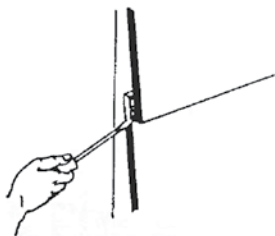

Fig 12.

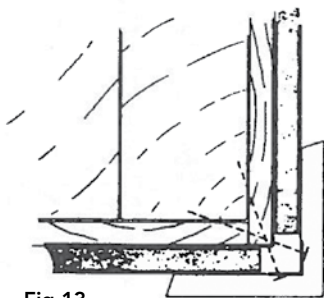

Fig 13.

Windows and Doors – Under

Try to avoid an end lap directly below a window.

Place the panel in position under the sill and mark the width of the window on it. (See Fig. 14).

Then place a small piece of siding next to the window, locking it into the panel below. Make a mark on this piece about 5 mm ($3/16''$) below the sill. (See Fig. 15).

The measurement taken from this small piece can then be marked on the panel. Cut two slots in the panel the width of the window. Score the panel between these cuts and break the section out.

Apply the panel in the normal way slipping the cut edge into the trim.

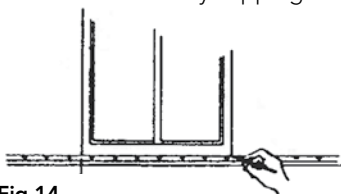

Fig 14.

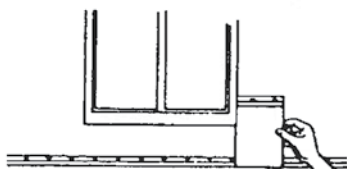

Fig 15.

Windows and Doors – Above

To cut a panel for the top of a window or door, follow the same procedure as for cutting out under an opening, but cut the base rather than the top of the panel, leaving 5 mm ($3/16''$) clearance from the horizontal surface of the Drip Cap. (See Fig. 16).

Hold the panel in place above the window and door and lay out the width. Measure from the lock of the lower panel to the horizontal surface of the Drip Cap and mark this distance plus 5 mm ($3/16''$) on the panel.

Cut this section out of the panel and apply it in the normal fashion.

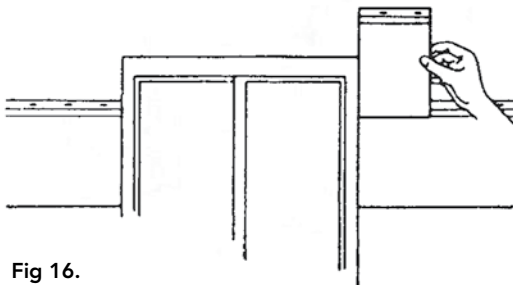

Fig 16.

Panel Between Openings

Cut the panel 3 mm (1/8") shorter than the distance between the openings if this distance is more than 1.5 m (5') and bow the panel slightly to fit into place. (See Fig. 17).

If the distance is less than 1.5 M (5'), use "L" trim instead of "J" trim and cut panel 3 mm (1/8") less than the distance between the openings.

Fig 17.

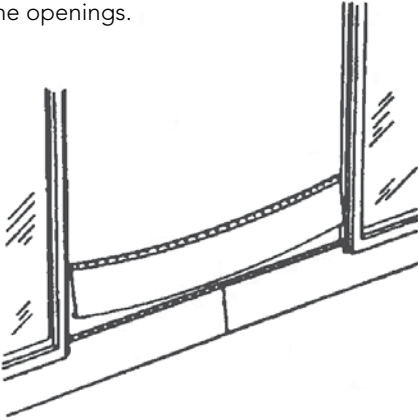

Porch Floors

(See Fig. 18)

Apply general purpose trim along the porch floor, flurring where necessary to keep panel in proper alignment.

Measure the length of the porch and mark on the panel.

Measure the distance from the lock of the lower panel to the general purpose trim. Make sure that the cut edge will fit at least 3 mm (1/8") into the trim. This will determine the width of section to be removed.

Cut out section and apply panel slipping cut edge behind trim.

Fig 18.

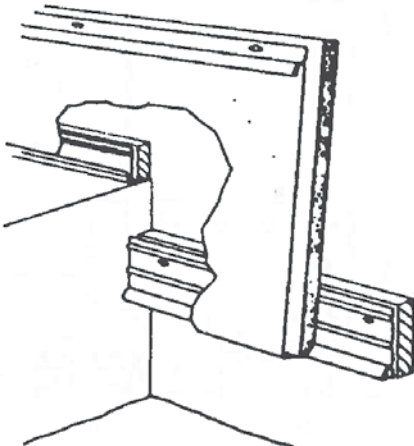

Under Eaves

(Excluding Gable Ends)

Apply general purpose trim under eaves, furring where necessary to maintain the correct panel angle. (See Fig. 19). Secure the trim with aluminum nails every 800 mm (32") using 38 mm (1 ½") nails for unbacked siding and 50 mm (2") nails for backed siding.

Cut the panel lengthwise and apply with the cut edge fitting into the trim.

For eaves at the gable ends, butt the cut edge of the panel into "J" trim nailed on 300 mm (12") centres.

If aluminum soffit is being installed on the house, proceed as follows: (Fig. 20).

Cut the top siding panels to fit as closely as possible into the corner formed by wall and soffit.

Fur under the cut edge to maintain the proper pitch.

Nail the siding panel, using 38 mm (1 ½") nails with unbacked and 50 mm (2") with backed siding keeping the nails as close as possible to the cut edge.

Install large "J" trim to cover the cut edge and nails.

All exposed nail heads must be painted to match siding colour. Fit the soffit directly into the "J" trim. Note that in this case the "J" trim must be installed after the siding panel instead of before.

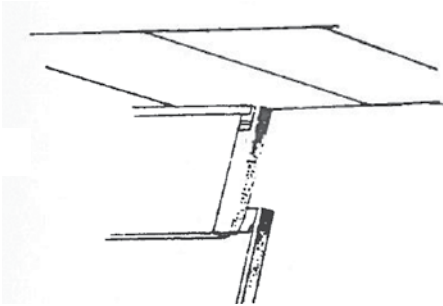

Fig 19.

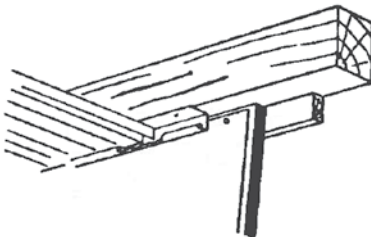

Fig 20.

Gable Ends

(Horizontal Siding)

If soffit is being used, install it first using soffit "J" trim at corner formed by wall and soffit.

For backed siding apply large "J" trim and for unbacked siding apply medium "J" trim at eave line under roof overhang and nail on 300 mm (12") centres. (See Fig. 21).

Make a pattern for cutting panels to fit the slope by taking two short pieces of panel, holding one horizontally on the lock of the next lower panel and the other up against the side of the gable. (See Fig. 22). Mark a line across the horizontal panel and cut. Use this pattern on each successive course until the peak is reached.

Check the slope each time to make sure that it is straight.

Butt each panel against the "J" trim and nail.

Use the same procedure above porch roofs. (See Fig. 23).

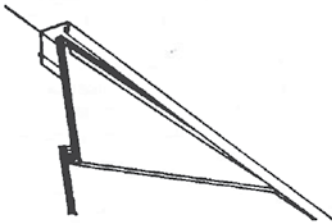

Fig 21. 11

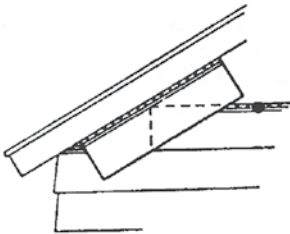

Fig 22. 22

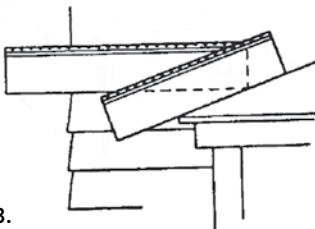

Fig 23.

Vertical Siding

(Trims)

If vertical siding is used as trim or for highlighting, remember to plan ahead for its use.

Snap a chalk line along the base of the house and apply belt line trim to serve as the base trim.

Apply soffit "J" trim under the eaves, under the roof overhang at gable ends, and around the sides and sills of windows and doors. At the top of windows and doors, use "Drip Cap". (See Fig. 7) on page 9.

Vertical Siding

(Panels)

Select a convenient starting point on any wall other than gable ends. Drop a plumb line from the eave to the foundation to locate the starting line. Nail starter strip along this line.

Measure and cut the panel to the required length.

Cut the batten off the panel and discard. (See Fig. 26).

Flatten the remaining shoulder with a hand brake.

Insert the cut edge of the panel under the starter strip and nail the opposite edge to the wall. Cut the second full panel to the proper length, engage in the starter strip and nail to the wall. (See Fig. 27). Apply furring horizontally over low spots where necessary. This will keep panels straight and add rigidity to the flat area of the panel. Install subsequent panels, working right and left from the centre, interlocking each with a firm, steady pull. Do not pull tightly to avoid distorting the shadow line.

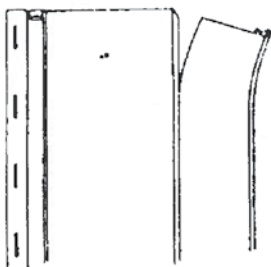

Fig 26.

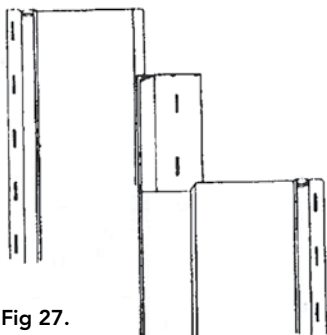

Fig 27.

Vertical Siding

(Corners)

Outside Corner: Cut the panel to length and engage it in the previous panel so that it projects past the corner.

Mark the position of the corner on the panel and bend it 90° on a brake. (See Fig. 28).

Inside Corner: Fit an inside corner in the same way but measure the distance to the corner and mark on the panel.

Bend 90° and install. (See Fig. 29).

If no brake is available on the job, the bend can be made as follows:

Engage the panel in position as before and mark it top and bottom 3 mm (1/8") out beyond the corner.

Remove the panel and lay it on a flat table, lining up the marks with the table edge.

Lay a 50 mm x 100 mm (2" x 4") of similar material over the panel on the edge of the table and clamp both ends tight. Place another 50 mm x 100 mm (2" x 4") on the overhang and push down to make the desired bend. (See Fig. 30).

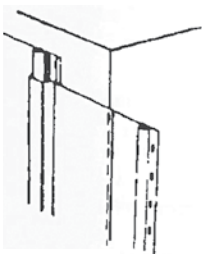

Fig 28.

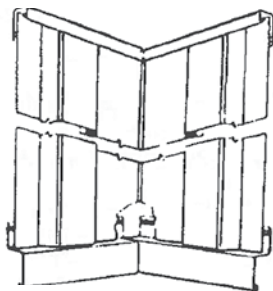

Fig 29.

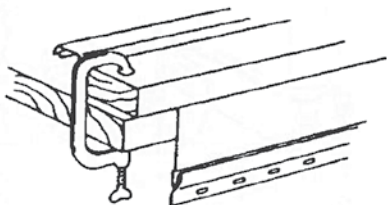

Fig 30.

Horizontal over Vertical

If both horizontal and vertical siding are to be used on a wall, make a horizontal chalk line at the level where the horizontal siding will begin.

Apply belt line trim and starter strip horizontally along this line and then apply horizontal siding in the usual manner. (See Fig. 31).

Snap another chalk line along the base of the house and apply belt line trim along this line.

Measure the distance between the upper and lower belt line trims and cut the vertical panels to this length. Allow sufficient clearance for expansion.

Install vertical siding as described previously: mark wall with vertical chalk line, apply starter strip, cut off panel batten and work right and left of centre.

Fig 31.

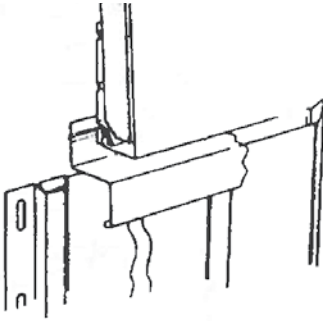

Vertical over Horizontal

First apply horizontal siding to the height on the wall where it will join the vertical.

Apply belt line trim over the last horizontal panel and nail on 200 mm (8") centres. (See Fig. 32).

Fig 32.

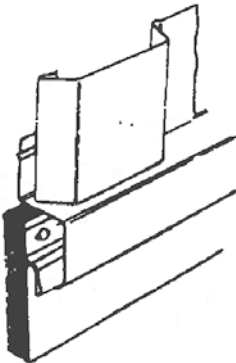

Butting Vertical and Horizontal

(See Fig. 33)

Cut either the lock or the batten from the vertical panel, depending on the direction of application.

Apply "J" trim to the wall, nailing it over and through the cut edge of the vertical panel.

Apply the horizontal panels in the usual manner, butting the ends of each panel into the "J" trim.

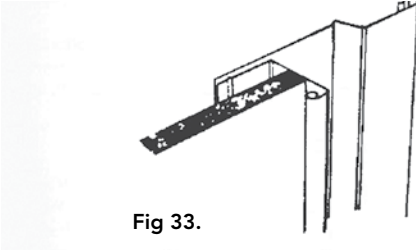

Replacing a damaged Panel

(See Fig. 34)

Cut the damaged panel horizontally with a utility knife about 6 mm (1/4") below the panel above and vertically on each side of the damaged area. Remove it by pulling downward.

Cut the replacement panel 25 mm (1") longer than the opening so it will tap 12 mm (1/2") on each end.

Cut the top interlock off the replacement panel to leave as much panel face as possible. (See Detail A).

At the butt edge of the replacement panel, remove enough of the interlock (See Detail B) to suit the width of the opening left by removal of the damaged section of panel.

This will allow the replacement panel to be slipped into place over the top of the opening in the old panel.

Push the replacement panel up to lock into the bottom interlock and nail the top through the 6 mm (1/4") section of the old panel, or nail through a weep hole in the replacement panel butt edge. (See Detail C).

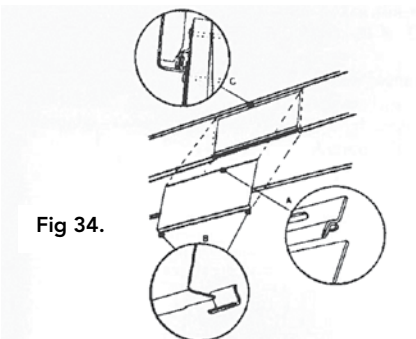

Clean-up

Wash the siding following the instructions given under "Maintenance". Apply touch-up paint after washing, using a small artist's brush, taking care to apply the paint to only scratched or scuffed areas.

Securely replace all exterior fittings.

Remove all rubbish and debris from the job site leaving the area clean and tidy.

Maintenance

Inform the homeowner of the following maintenance procedures. Wash with only a soft cloth or soft bristle brush (such as a car wash brush).

For very light deposits of dirt, wash with clean, warm water and dry with a soft cloth.

For heavier deposits, wash with water containing a little mild soap or household detergent.

DO NOT USE ABRASIVE CLEANERS.

Rinse thoroughly with clean water.

For dirt which will not wash off with soap or household detergents, refer to Gentek Building Products Limited for assistance. Wash any scratches in the enamel with water and touch up with touch-up paint or an air drying enamel recommended by a reliable paint manufacturer.

Estimating

Preparation: Calculate the area of each wall using the following method, and add up the following areas:

Walls: Multiply the height of each wall by its width.

Horizontal siding, in lengths of 200 mm (8"): For easier calculation, take measurements in mm, that is in lengths of 200 mm, and use multiples of 200. You must add one extra multiple of 200, if the count of multiple does not add up to the exact height of the wall to be sided.

Example: If the wall is 2.5 m high (98"), which means more than 12 multiples of 200 mm, use 2.6 m (approx. 104"), that is, 13 multiples.

Vertical Siding: the same procedure applies, except that you must take into account the width of the wall to be sided.
Gable ends: Multiply gable height by $\frac{2}{3}$ of its width, to compensate for waste of material inherent to the wall's special geometry.

Irregular wall shapes: Divide the wall in rectangles or triangles, as the case may be. Calculate the area of each rectangle by multiplying its height by its width, or calculate area of each triangle by multiplying its height by $\frac{2}{3}$ of its width. Compensate for waste of material accordingly.

Openings: To compensate for waste of material, do not deduct the area of openings, such as doors and small windows. Divide the total area in square metres by 9 (by 100, in square feet) to determine the amount of material required.

Ordering Material

Accessories

Accessories, touch-up paint and caulking are available in Gentek approved colours matching those of Gentek siding. Use matching colours for all exposed accessories and caulking.



GENTEK®

GENTEK BUILDING PRODUCTS

Product Improvement Policy: Gentek Building Products is constantly improving product designs and manufacturing processes. We therefore must reserve the right to change specifications without notice. Please consult Gentek Building Products for current details. © 2013, Gentek Building Products.

Visit our site at www.gentek.ca