

VINYL PRODUCTS INSTALLATION G U I D E

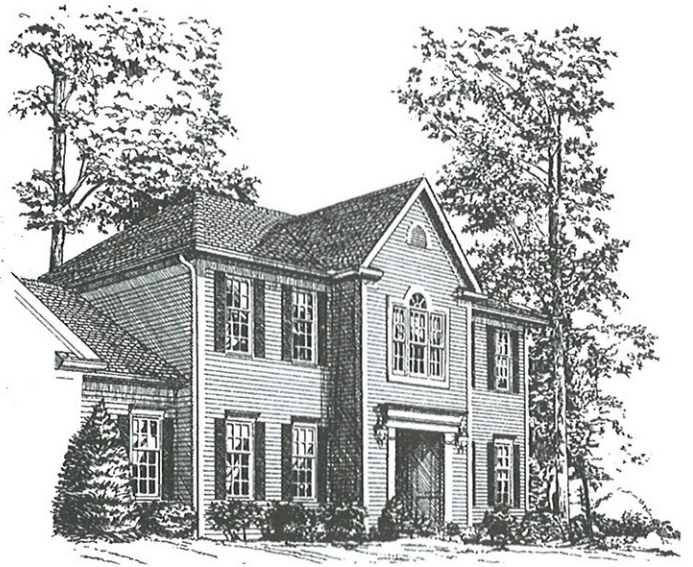

GENTEK®

General Information

Gentek vinyl products, horizontal and vertical siding and soffit, are easy to apply when the job is planned and the simple directions in this manual are followed.

Step-by-step instructions should be followed in the proper sequence to avoid problems.

Vinyl expands and contracts with changes in temperature. The amount is approximately 8 mm (1/3") in a 3m (10') length for a temperature change of 55°C (131°F). To allow for this normal movement, nailing slots and nailing instructions are provided. All measurements are written in the SI metric system. Nominal imperial equivalents are provided in brackets.

Re-Siding

Remove shutters, downspouts and other outside fixtures. Nail down loose boards or shingles, and replace any that have decayed. Check sidewalls and base for level and straightness. Uneven walls or masonry may require strapping, which should be shimmed where necessary to ensure an even finished siding installation.

New Construction

Installation must meet requirements of Provincial Building Codes, CCMC Residential Standards or other applicable codes.

Tools and Equipment

- Work table
- Carpenter's square
- Plumb bob and chalk line
- Hand power saw or radial arm saw (with an abrasive wheel or plywood cutting blade)
- Tape measure
- Level
- Ladders
- Staging
- Hammer
- Tin snips
- Snap lock punch
- Nail slot punch
- Zip tool
- Utility knife

Note

The wearing of some form of eye protection is standard safe working practice when using a saw to cut any type of material. Good safety practice is important at all stages of installation. Take the time to do things safely.

Gentek Building Products Limited Installation Guides are for information only. If you are unsure of any procedure, consult Gentek Building Products Limited or a qualified tradesman for advice. They can provide the information you need – and save you time and trouble.

Product Improvement Policy: Gentek Building Products Limited is constantly improving product designs and manufacturing processes. We therefore must reserve the right to change specifications without notice. Please consult Gentek Building Products Limited for current details. Products may not be exactly as shown.

Basic Rules

Following these basic rules will ensure proper installation, with sufficient allowance for expansion and contraction during changes in temperature.

1. Unless indicated otherwise in this manual, always place the nails in the centre of the nailing slot. Never nail through the siding material itself. Never nail too tightly. Vinyl siding is not "nailed" to the wall - it is "hung" on the nails, allowing the free movement of each panel.
2. All siding and accessories should be overlapped - except where noted otherwise.
3. Where panels fit into accessories, a 6 mm (1/4") clearance should be left for normal expansion and contraction. If the temperature is below freezing at the time of application, the minimum clearance should be 12 mm (1/2").
4. When nailing horizontal siding, gently lift top panel so that locks just touch.
5. When fastening vertical siding and corner posts, start by positioning nail in the top of the uppermost slot to hold in position. Place all other fasteners in the centre of slots.

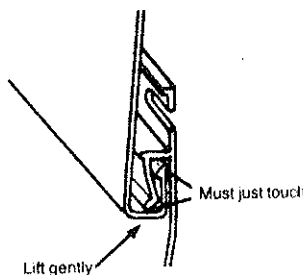
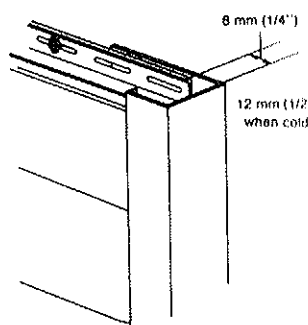
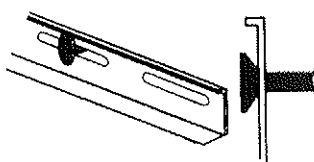
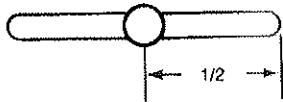

Nailing

Use large head corrosion resistant roofing nail, with a minimum head diameter of 8 mm (5/16"). They must be long enough to anchor a minimum of 20 mm (3/4") in solid wood framing or cladding. Nail siding and accessories a minimum of 150 mm (6") from the ends when overlapping.

Caulking

Caulking is necessary in areas where water penetration is possible (pipes or wires through walls, or J-channels on sides of windows or doors). Use only good quality caulking - with a sustained flexibility, good extensibility and long life. **DO NOT USE OIL BASE CAULKING.**

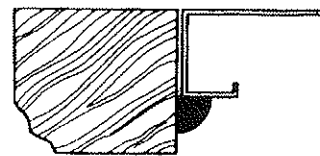

1. All accessories except the starter strip and F-channel must be overlapped. Shaded areas are 40 mm (1 1/2") portions to be cut out for proper overlapping. Overlap only one half (20 mm (3/4")) of this length.
2. All material must be nailed as shown, or as stipulated in these instructions.

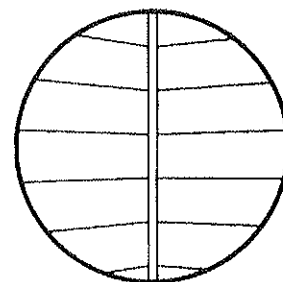
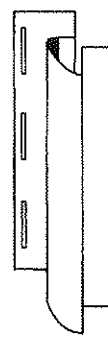

Inside Corner Post

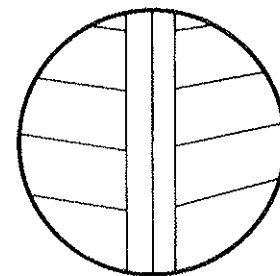
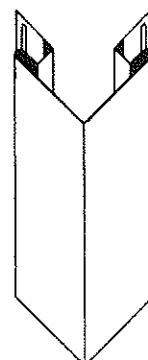

Outside Corner Post

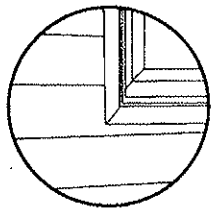
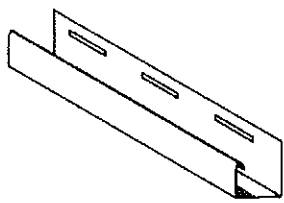

J-Trim

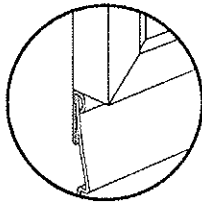
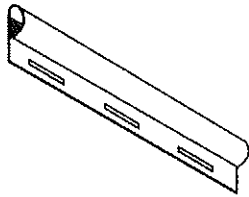

Undersill Trim

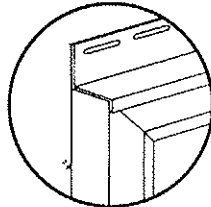
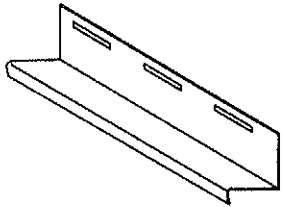

Drip Cap

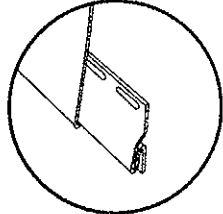
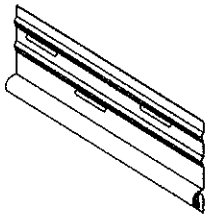

Starter Strip

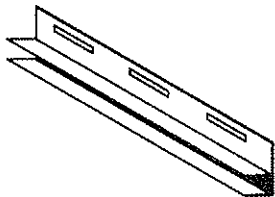

F-Channel

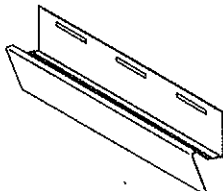

Beltline

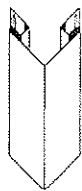

Outside Corner Post



Inside Corner Post

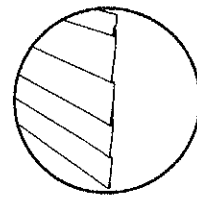

Siding

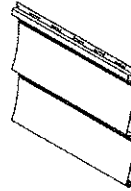

**Double 4
Double 5**

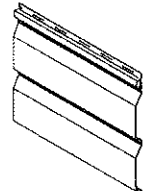

**Double 4 Cove
Double 5 Cove**

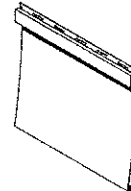

Horizontal 8"

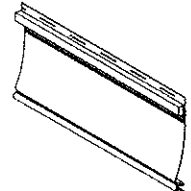

6.5" Beaded

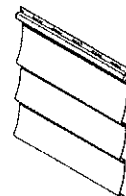

Triple 3

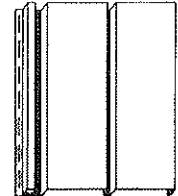

Vertical

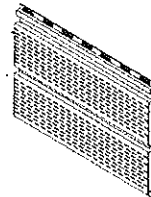

2 Panel Vented Soffit

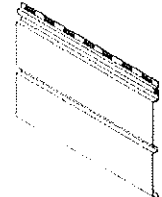

2 Panel Plain Soffit

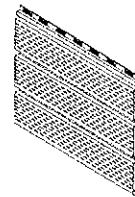

3 Panel Vented Soffit

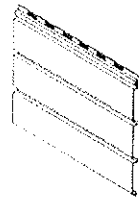

3 Panel Plain Soffit

STEP 1

Horizontal Sidings

The first step, whether you are re-siding or applying on new construction, is to determine where you will apply the first course of siding. This can be at the same level as the old siding, or, on new construction, at a level that will cover the edge of the foundation. Use a chalk line and a level to obtain a horizontal starting point so that all installed siding will be perfectly level. And at all corners, use a plumb line to ensure that corner posts are vertical.

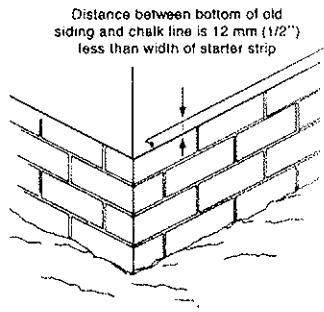

Follow these steps in the order shown for the easiest and best application.

STEP 2

Install Outside Corner Post

Cut post to the length required. Begin nailing at the top of a slot, halfway up the post. The balance of the nailing must be in the centre of the slots. If more than one length is required, refer to the preceding section for cutting and overlapping instructions.

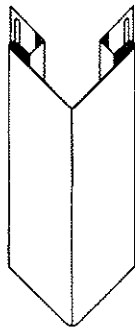

Note

If a corner post is to be cut, place cut end at the **top**, away from the general sight line.

Staggered nailing will reduce stress and ensure more even installation of the corner post. Nail first up and then down post, alternating sides as you nail.

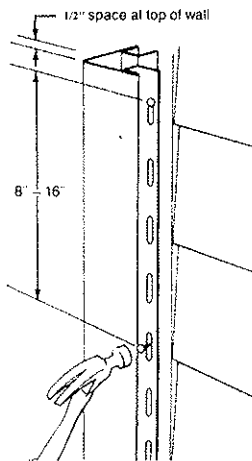

- 8 -

Inside Corner Post

Cut post to the length required. Begin nailing at the top of a slot, halfway up the post. The balance of the nailing must be in the centre of the slots. If more than one post is required, refer to the preceding section for cutting and overlapping instructions.

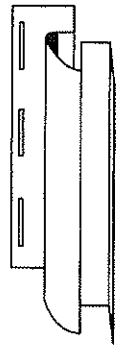

STEP 3

Starter Strip

With a tape measure, measure the width (w) of the starter strip. Determine, as explained in General Information, where the bottom of the first course will begin. Measure up from this mark, the width of the starter strip, less 12 mm (1/2"), and chalk a level line across the wall. Keep the starter strip 6 mm (1/4") from the nail hems of both the inside and outside corner posts. Nail at 200 to 250 mm (8" to 10") centres. Leave 12 mm (1/2") gap between ends of adjacent starter strips.

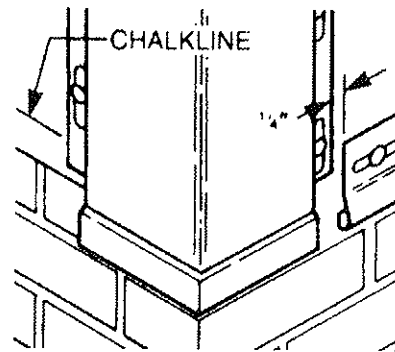
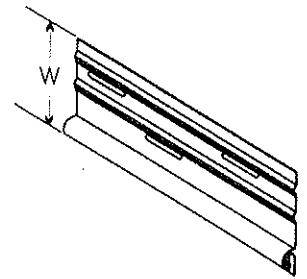

- 9 -

STEP 4

Trim Doors, Windows, and Other Openings

J-Channel

J-channels are used as trim on the sides of windows and doors and as finishing trim on gable ends. Place J-channels on the sides of the window and door frames, extending trim 25 mm (1") past top and bottom edge of the frame. Face will be trimmed back for good visual appeal.

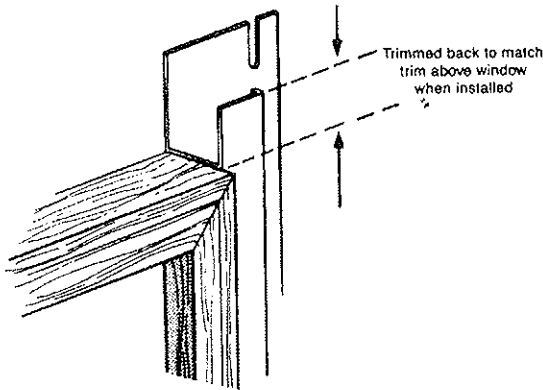
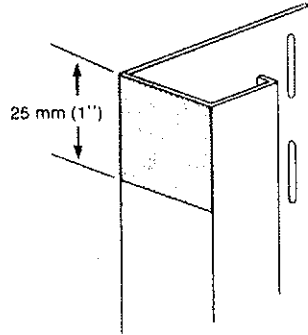

Undersill Trim

This trim is used above and below openings, and at the top of walls adjoining soffits. Undersill trim can be furred out to preserve the proper panel angle. Apply a furring strip to the wall, butting it to the underside of the window sill.

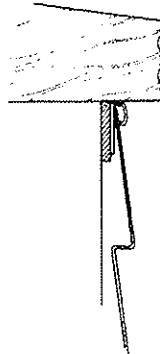

Install the undersill trim, extending it past either side of the window, as far as the outer edge of the J-channel face.

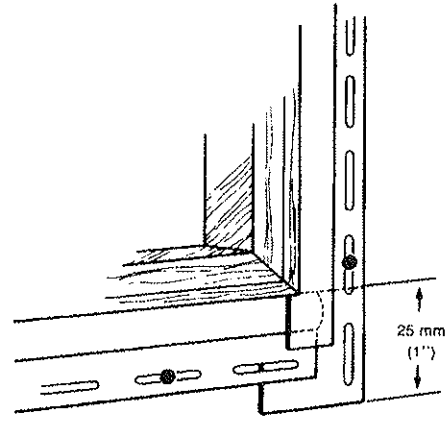

Undersill trim is also used in an inverted position over the tops of windows and doors and where trims butt against window framing.

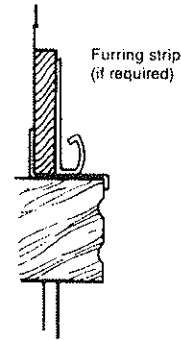

Caulk where J and sill trims meet the opening frame.

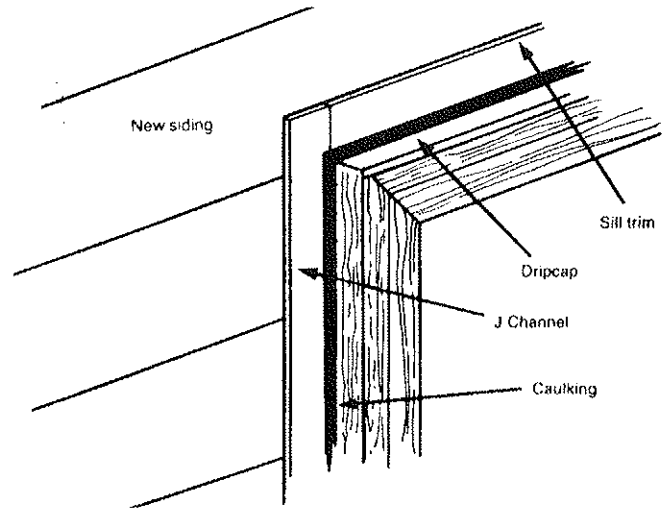

Drip Cap

The drip cap is nailed above the window and door and extended on either side, flush with the exposed leg of the J-channel. A tab is cut at either end of the drip cap and bent down over the J-channels. If required to maintain panel angle, a furring strip is nailed over the drip cap.

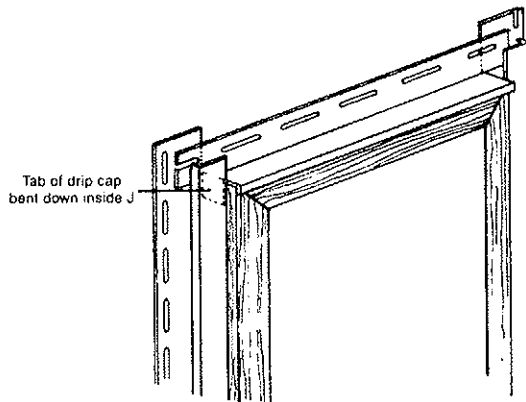

The undersill trim, installed in a reversed position, must be extended on both sides, flush with the outer edge of the J-channel. Remove indicated shaded area to allow siding to fit into J and into undersill.

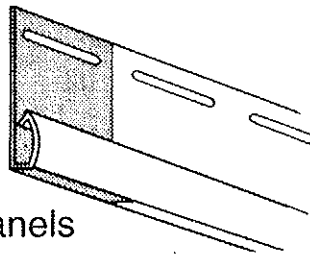

STEP 5

Install Siding Panels

The first siding panel is engaged in the starter strip and nailed. If the siding can be moved laterally after being locked up, a positive lock has been achieved. Continue nailing on 400 mm (16") centres (and not over 200 mm (8") centres in high wind areas). Leave 6 or 10 mm (1/4" or 3/8") of space where siding fits into accessories to allow for expansion. When installing below freezing - leave 1/2".

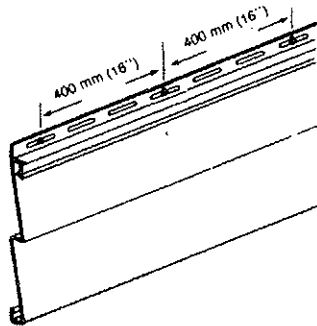

Overlap the vinyl panels half the dimensions of the factory notch. For good appearance, laps should be away from traffic areas and staggered horizontally a minimum of 600 mm (2') from one course to the next. Do not "repeat" an overlap in one vertical line for a minimum of 3 courses. When overlapping **do not nail closer than 150 mm (6")** from the ends of both panels. Refer to the section on Tools for proper cutting equipment. If using a power saw, reverse the blade on the saw shaft for easier cutting, and use a fine tooth plywood blade.

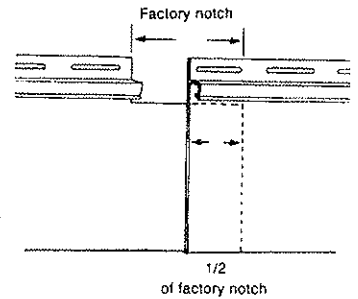

Installing Siding Around Windows and Doors

To fit the siding under windows and doors or under the eaves, measure the distance from the bottom edge of the lock on the undersill trim to the bottom edge of the top lock of the last full siding panel. Add 16 mm (5/8") to this measurement to allow the panel edge to engage in the undersill trim.

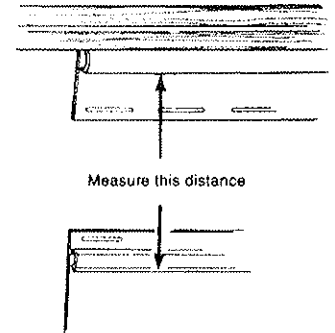

- a. Cut the siding panel to the adjusted measurement under windows or at finish of siding installation.

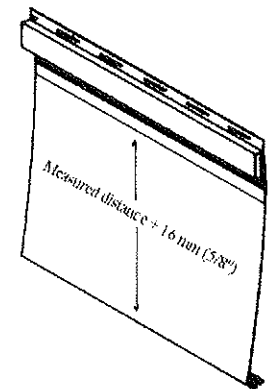

b. Using the snap lock punch, punch ears in the trimmed edge of the siding panel at 200 mm (8") intervals. Be sure that the "ears" face outwards from the wall.

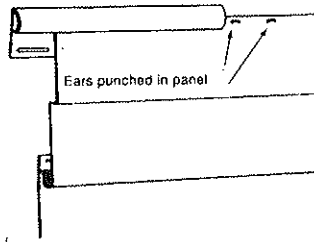

c. Lock the top edge of a siding panel in the undersill trim and secure the lock at the lower edge of the panel. The snap lock punch must be used whenever the trimmed edge of a panel is to be engaged in the undersill trim.

To fit the siding over the top of windows and doors, cut out the bottom section of the panel leaving 10 mm (3/8") clearance on both sides of the window, so that the horizontal edge of the cut out fits firmly into the undersill trim.

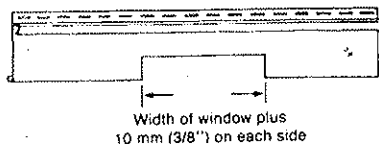

Note: For good visual appeal, plan your siding installation so that any laps required in the course of siding immediately below a window can be placed below that window.

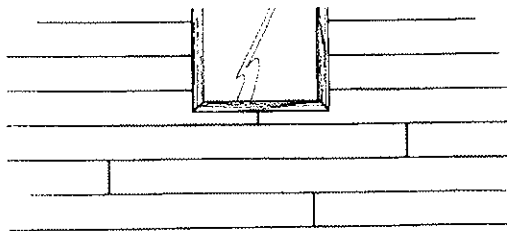

STEP 6

← Minimum 600 mm (2') →

Top-of Wall Finish

Siding is measured and finished off at the top of the wall in exactly the same fashion as under a window or door, as explained in installing siding around windows, and doors, except that full sheets of siding will be used.

To finish siding on gables install a J-channel along the gable angle against the soffit. Cut siding to the proper angle and install soffit in the J-channel, leaving gap for expansion (See Basic Rules, #3).

If gables are being finished with vertical siding as an accent, install the last panel of horizontal siding in the normal manner, then install back to back J-channels or vertical belt line trim. This trim will serve as the starter strip for the vertical siding.

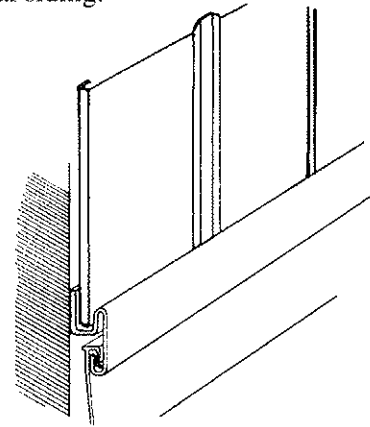

Installing Vertical Siding on Main Walls

Refer to pages 4 and 5 for the accessories to be used for vertical siding installation, and for method in which these are cut for overlapping.

STEP 1

Vertical J-Channel

Vertical J-channel serves as starter strip for vertical siding. Use a chalk line and level to ensure the J is straight and level. Install J-channel along chalk line as a receiver for the vinyl siding. The J should drop below the old siding, forming a drip edge. If a drip edge cannot be made, install base flashing to be sure water drains clear of the structure.

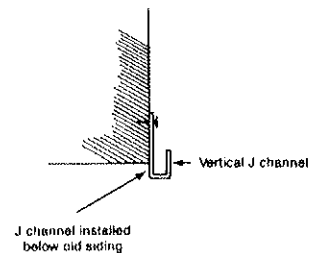

STEP 2

Corner Posts

The outside and inside corner posts are installed in exactly the same way as shown in Steps 1 and 2 of the horizontal siding instructions. The corner posts must overlap the trims at the bottom of the wall.

STEP 3

Trim Around Windows, Doors and Other Openings

Install J-channel down the sides of windows and doors or inverted along the gable slope or top of wall, as explained in Step 4 of the horizontal siding instructions, leaving gap for expansion. Install drip cap over windows and doors and then install vertical J, all as illustrated. Install vertical J-channel below windows and doors, as illustrated.

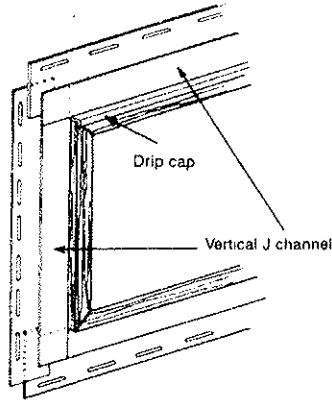

STEP 4

Installing Siding

For ease of application, vertical installations should start at the corner post. Partially fill the throat of the corner post with furring strip 50 mm (2") wide. Leave sufficient space to install an undersill trim vertically, over the furring, in the throat of the post.

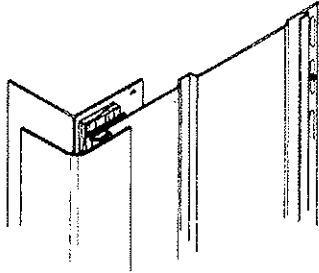

Cut off the locking leg of the first panel, and with a snap lock punch perforate the edge of the panel at 300 mm (12") intervals. Make sure that the punched "ears" face outwards from the building. Lock the punched edge of the panel into the undersill trim and nail the vertical panel in place, through the nail slots. Subsequent panels are interlocked and nailed in place. The final panel is measured and cut to size, perforated with the snap lock punch and snapped into the undersill trim. Before installing any siding, measure the width of the wall to ensure that the last panel will fit into an undersill trim in the corner.

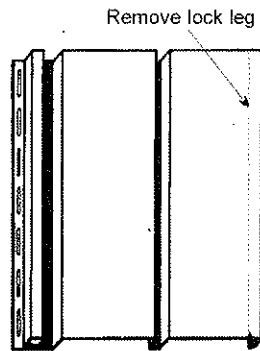

- 16 -

Installing Vertical Siding on Gable Ends

The installation of vertical siding on gable ends is very similar to any other vertical installation, except that you start with a very small piece, and, for a clean look, you want to have the groove of the vertical panel in line with the peak of the gable.

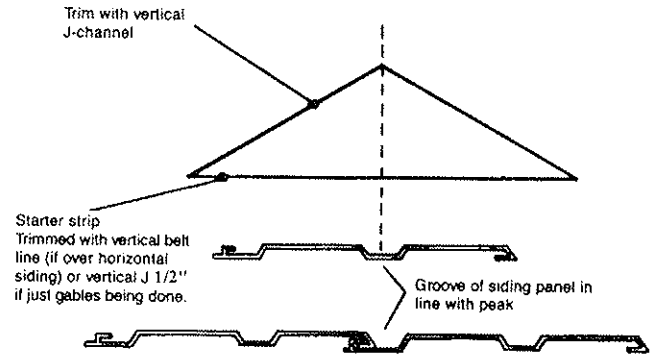

Trim the perimeter of the gable with vertical J-channel (1/2"), overlapping a joints. If horizontal siding is installed below vertical, use Vertical Belt Line as a starter strip at the bottom of the gable. (Ensure the starter strip is level).

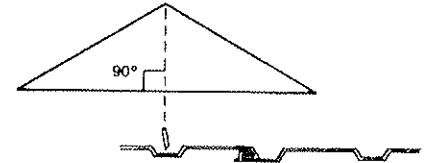

At the peak of the gable, drop a chalk line perpendicular to the starter strip. To determine where to start the first panel-measure from chalk line along the starter strip in units of 127 mm (5") until you get to a point where the measurement to the J channel is less than 127 mm (5"). Mark that point with a pencil. Measure back toward the centre of the gable from that point 32 mm (1 1/4"), and draw a vertical line, parallel to the line dropped from the gable peak. This line is the position of the edge of the nail hem on the first panel.

- 17 -

Measure the first panel, cut and install. Install subsequent panels, increasing in length as the peak rises. Every 3 panels be sure to check for plumb and also measure to the centre chalk line to ensure that you are going to arrive at the peak with a centre groove in line with it. Make needed small adjustments by pushing the panels "in" or "out" within the lock. The lock should face away from the general viewing area.

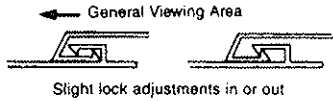
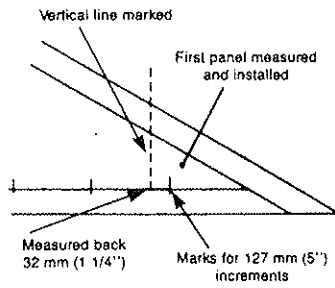

Soffit and Fascia

Refer to page 5 for the accessories that should be used with the soffit and fascia system. In installing the soffit, the object is to provide two parallel slots, one on the house and one on the bottom of the fascia which will support the soffit panel.

STEP 1

F-channel or J-channel is used to provide a support at the wall of the house. When the soffit areas are open (A) a piece of wood is nailed to the wall of the house and the vertical J is nailed to this. Alternatively, an F-channel can be installed against the wall of the house in an inverse (upside down) position. If the soffit area is closed (B), 1/2" J is nailed to the wooden soffit. If the fascia is lower than the wooden soffit, F-channel can be used, as in (A). Nail trims on 300 mm (12") centres.

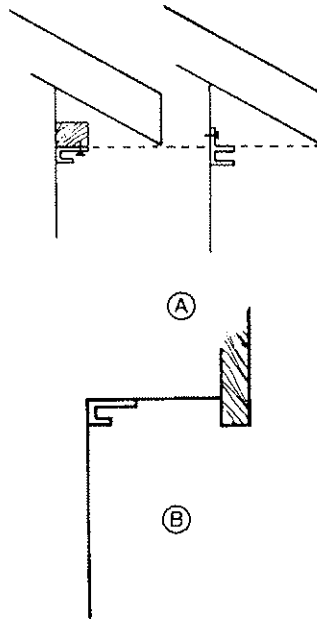

STEP 2

The outer end of the soffit area can be trimmed in one of two ways.

If aluminum fascia is going to be installed over the soffit panels, no trim is required at the fascia. The soffit panels are installed level with the bottom of the wood fascia board, and are nailed into the bottom of this board.

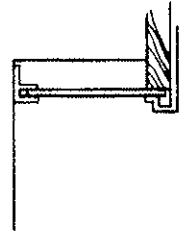

If there is no aluminum fascia (i.e. wooden fascia will still be exposed), the new soffit should be installed over the existing soffit, using a J-channel against the wooden soffit. If the wood fascia is thick (e.g. 2x6x2 lumber), then an F-channel may be used, allowing you to drop the soffit if desired.

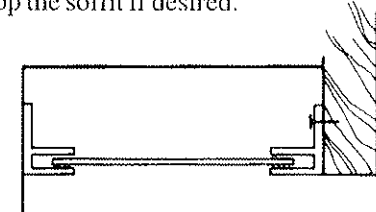
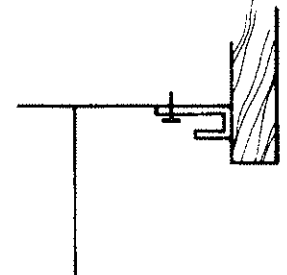

Note

J-channel must be notched, as shown, 40 mm (1-1/2") long and overlapped half of this amount.

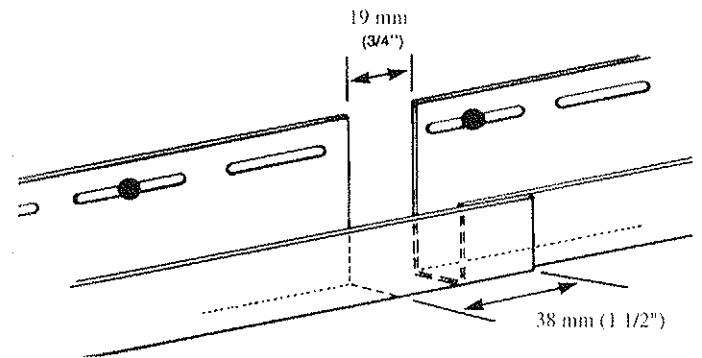

STEP 3

Measure between the interiors of the two channels and subtract 12 mm (1/2"). For distances over 1.5 m (5') subtract 20 mm (3/4"). See general notes at front of guide on product expansion.

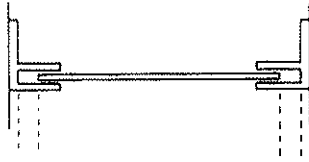

Place the soffit panel in the channels and nail each panel into existing old soffit or other wood framing at the wall of the house. Lock subsequent panels together and nail. Intermediate nailing is required on any panel over 500 mm (20") in length.

Trim both ends of the soffit run with F-channel or J (1/2") channel to finish the job.

Where two soffit sections meet, there are two ways of making the joint. The joints are made with J (1/2") channels properly supported and nailed back to back.

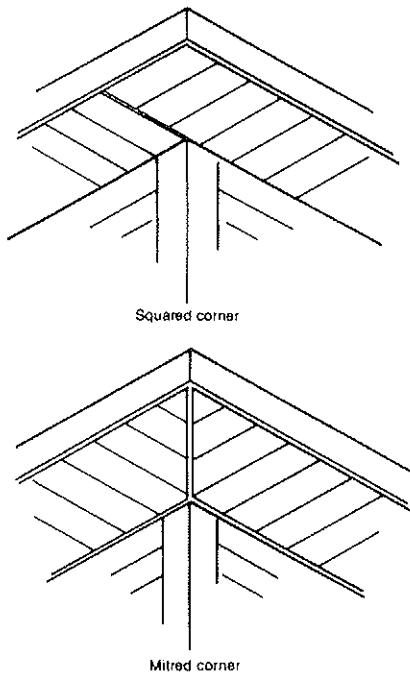

Ventilation Requirements

New Construction

The National Building Code states that every roof space or attic above an insulated ceiling shall be ventilated with openings to the exterior to provide unobstructed vent area of not less than 1/300th of the insulated ceiling area. Vents may be roof type, eaves type, gable end type, or any combination of these and shall be uniformly distributed on opposite sides of the building. Vents shall be designed to prevent the entry of rain, snow and insects. Note that some regulatory authorities require at least 50% of the total vent area to be in the roof overhang. Check the requirements in your local area.

Renovations

Through the National Building Code, the CCMC Residential Standards or other codes are not generally applicable to renovation, it is good practice to provide a total vent area which is a minimum 1/300th of the insulated ceiling area and to distribute it uniformly on opposite sides of the building. Further, it is recommended that, where possible, the existing soffit vent area and the existing soffit vent locations be retained in the application of new soffit.

Note

Each 3.66 m (12') panel of soffit contains .045 m² (69.6 in²) free flow ventilation area. To determine the **minimum** number of panels you should have, assuming that the total ventilation requirement is provided by the soffit, use the following formula:

$$\text{metric} = \frac{\text{attic space (square metres)}}{20}$$

or

$$\text{imperial} = \frac{\text{attic space (square feet)}}{200}$$

NOTES

NOTES



GENTEK®
GENTEK BUILDING PRODUCTS LIMITED

Product Improvement Policy: Gentek Building Products Limited is constantly improving product designs and manufacturing processes. We therefore must reserve the right to change specifications without notice. Please consult Gentek Building Products Limited for current details. © 2002, Gentek Building Products.

Visit our site on the world wide web:  www.gentek.ca

Printed in Canada 12/03

629-1000E